

## Tapa protectora TM

N.º ref. 24995



- Para clavijas estancas al agua y clavijas semiempotrables (Forma G)

## Especificaciones técnicas

Peso	118 g
------	-------

## Planos y dimensiones

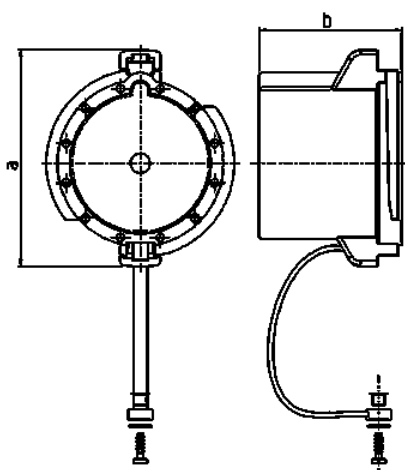

Plano	Amp. Polos	63			125		
		3	4	5	3	4	5
2 MB 239							
Dim. en mm	a		110			120	
	b		73			79	