

**DELTA-BOX**  
N.º ref. 92655



- precablados per l'installazione
- con abrazaderas antitracción
- caja e inserto fabricados en AMAPLAST

Especificaciones técnicas

CEE 16 A, 5 p, 400 V	2
SCHUKO®	2
Conexión / cable de alimentación	• para 1 cable de 5 x 10 mm <sup>2</sup>
Grado de protección	IP 44
Protección para niños	false
Material	plástico
Peso	1010 g

Planos y dimensiones

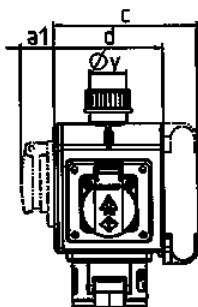
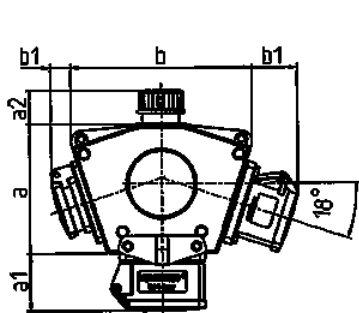

3 MB 44			
Imagen	Bases	IP	Dim.
a			114,0 mm
a1	SCHUKO®, 16 A, 230 V	IP 44	max. 30,0 mm
a1	CEE 16 A, 3 p, 230 V	IP 44	52,7 mm
a1	CEE 16 A, 5 p, 400 V	IP 44	50,5 mm
a1	CEE 32 A, 5 p, 400 V	IP 44	64,0 mm
a2			30,0 mm
b			160,0 mm
b1	SCHUKO®, 16 A, 230 V	IP 44	max. 18,0 mm
b1	CEE 16 A, 3 p, 230 V	IP 44	42,0 mm
b1	CEE 16 A, 5 p, 400 V	IP 44	40,0 mm
b1	CEE 32 A, 5 p, 400 V	IP 44	53,2 mm
c			133,0 mm
d			97,0 mm
y			17,0 mm