

Clavija mural
N.º ref. 362



- Contacto roscado

Especificaciones técnicas

Amperios	125 A
Polos	4 p
Voltios	110 V
Sentido horario	4 h
Hertzios	50-60 Hz
Técnica de conexión	bornas de tornillo
Contactos	estándar
Grado de protección	IP 67
Peso	2061 g
Marca de verificación	EAC, CQC

Planos y dimensiones

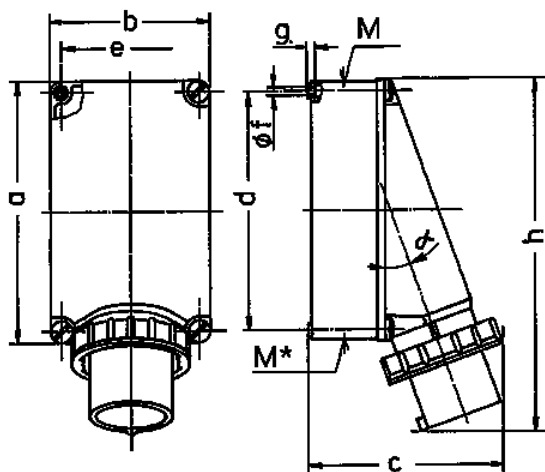

Plano	Amp.	63			125	
		3	4	5	4	5
2 MB 36	Polos					
Dim. en mm	a	170	170	170	264	264
	b	118	118	118	163	163
	c	171	171	171	205	205
	d	134.5	134.5	134.5	240	240
	e	103	103	103	140	140
	f	6,1	6,1	6,1	8,1	8,1
	g	6	6	6	8	8
	h	250	250	250	355	355
	M	40	40	40	50	50
	M*	2x40	2x40	2x40	50	50
	α	25°	25°	25°	20°	20°
	Ø y [max]	27	27	27	38	38
	Borna para cond. Sección	6	6	6	16	16
	Transvers. (mm²) min.-max.	-16	-16	-16	-35	-35