

Clavija semiempotrable

N.º ref. 1257



- Contacto roscado
- con tapa protectora

Especificaciones técnicas

Amperios	63 A
Polos	4 p
Voltios	500 V
Sentido horario	7 h
Hertzios	50-60 Hz
Técnica de conexión	bornas de tornillo
Contactos	estándar
Grado de protección	IP 67
Peso	659 g
Marca de verificación	EAC

Planos y dimensiones

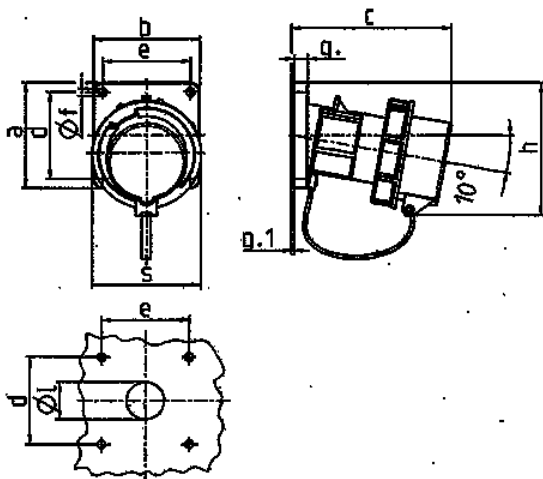

Plano	Amp.	16		32			63		
		3	5	3	4	5	3	4	5
2 MB 62	Polos								
Dím. en mm	a	85	85	85	85	85	108	108	108
	b	85	85	85	85	85	101	101	101
	c	132	132	131	131	137	164	164	164
	d	70	70	70	70	70	85	85	85
	e	70	70	70	70	70	77	77	77
	f	6,3	6,3	6,3	6,3	6,3	6,5	6,5	6,5
	g	11	11	11	11	11	12	12	12
	g.1	2	2	2	2	2	2	2	2
	h	100	107	108	108	111	130	130	130
	s	70	87	94	94	102	114	114	114
	l	30	30	30	30	30	40	40	40
	Borna para cond. Sección	1	1	2,5	2,5	2,5	6	6	6
	Transvers. (mm²) min.-max.	-2,5	-2,5	-6	-6	-6	-16	-16	-16