

Clavija mural con inversor de fases

N.º ref. 2511



- Contacto roscado

Especificaciones técnicas

Amperios	16 A
Polos	5 p
Voltios	400 V
Sentido horario	6 h
Hertzios	50-60 Hz
Técnica de conexión	bornas de tornillo
Contactos	estándar
Grado de protección	IP 44
Peso	248 g
Marca de verificación	VDE, EAC, CQC

Planos y dimensiones

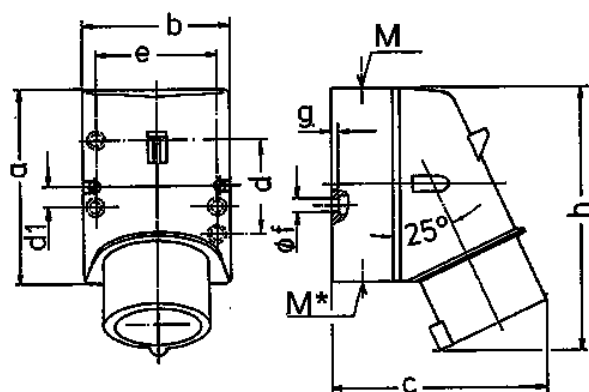

Plano 2 MB 32 Dim. en mm	Amp. Polos	16			32			
		3	4	5	3	4	5	
a		87	100	100	128	128	128	
b		64	75	75	84	84	84	
c		93	106	110	133	133	135	
d		40	—	—	—	—	—	
d1		—	10,5	10,5	11	11	11	
e		50,5	59	59	68	68	68	
f		4,5	5	5	5,3	5,3	5,3	
g		4	4	4	4	4	4	
h		122	133	135	169	169	170	
M		20	20	20	32	32	32	
M*			1x20 Ø y [max]			2x25 Ø y [max]		
Ø y [max]		15	15	15	18/25	18/25	18/25	
Borna para cond. Sección		1	1	1	2,5	2,5	2,5	
Transvers. (mm²) min.-max.		-2,5	-2,5	-2,5	-6	-6	-6	