

Clavija mural con inversor de fases

N.º ref. 3342



- Contacto roscado

Especificaciones técnicas

Amperios	16 A
Polos	4 p
Voltios	230 V
Sentido horario	9 h
Hertzios	50-60 Hz
Técnica de conexión	bornas de tornillo
Contactos	estándar
Grado de protección	IP 44
Peso	241 g
Marca de verificación	EAC

Planos y dimensiones

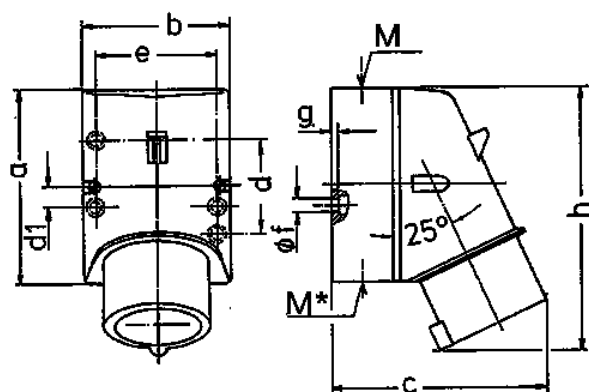

Plano 2 MB 32	Amp. Polos	16			32			
		3	4	5	3	4	5	
Dim. en mm	a	87	100	100	128	128	128	
	b	64	75	75	84	84	84	
	c	93	106	110	133	133	135	
	d	40	—	—	—	—	—	
	d1	—	10,5	10,5	11	11	11	
	e	50,5	59	59	68	68	68	
	f	4,5	5	5	5,3	5,3	5,3	
	g	4	4	4	4	4	4	
	h	122	133	135	169	169	170	
	M	20	20	20	32	32	32	
	M*		1x20 Ø y [max]			2x25 Ø y [max]		
	Ø y [max]	15	15	15	18/25	18/25	18/25	
	Borna para cond. Sección	1	1	1	2,5	2,5	2,5	
	Transvers. (mm²) min.-max.	-2,5	-2,5	-2,5	-6	-6	-6	