

## Clavija semiempotrable

N.º ref. 464



- Contacto roscado
- con tapa abatible

## Especificaciones técnicas

Amperios	32 A
Polos	3 p
Voltios	230 V
Sentido horario	6 h
Hertzios	50-60 Hz
Técnica de conexión	bornas de tornillo
Contactos	estándar
Grado de protección	IP 67
Peso	331 g
Marca de verificación	EAC

## Planos y dimensiones

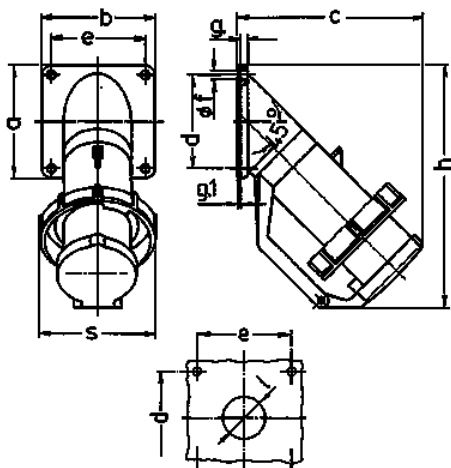

Plano	Amp.	16		32		63	
		5	3	4	5	4	5
<b>2 MB 40</b>	<b>Polos</b>						
<b>Dim. en mm</b>	<b>a</b>	85	85	85	85	114	114
	<b>b</b>	85	85	85	85	114	114
	<b>c</b>	141	141	141	144	180	180
	<b>d</b>	70	70	70	70	90	90
	<b>e</b>	70	70	70	70	90	90
	<b>f</b>	6,2	6,2	6,2	6,2	6,2	6,2
	<b>g</b>	6	6	6	6	6	6
	<b>g.1</b>	2	2	2	2	2	2
	<b>h</b>	181	181	181	188	242	242
	<b>s</b>	86	93	93	100	113	113
	<b>l</b>	30	30	30	30	40	40
	<b>Borna para cond. Sección</b>	1	2,5	2,5	2,5	4	4
	<b>Transvers. (mm²) min.-max.</b>	-2,5	-6	-6	-6	-16	-16