

Base mural
N.º ref. 5113A



- Contacto roscado
- X-CONTACT®
- Desconectable
- Bloqueo mecánico DUO
- Se cierra con candado

Especificaciones técnicas

Amperios	63 A
Polos	5 p
Voltios	400 V
Sentido horario	6 h
Hertzios	50-60 Hz
Técnica de conexión	bornas de tornillo
Contactos	X-CONTACT®
Grado de protección	IP 67
Material	plástico
Peso	2564 g
Marca de verificación	EAC, CQC

Planos y dimensiones

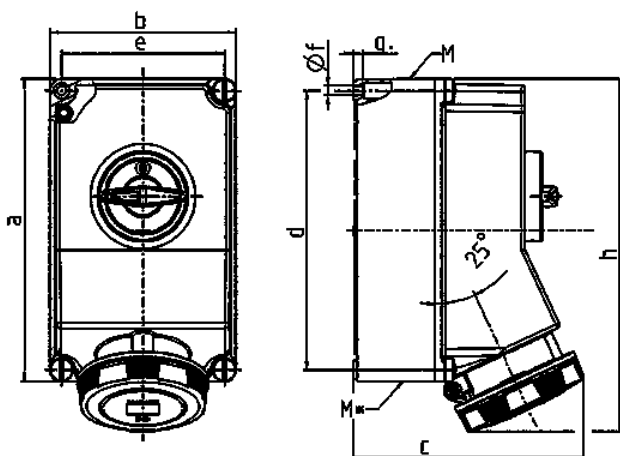

Plano 1 MB 180 Dim. en mm	Amp. Polos	63		
		3	4	5
a		260	260	260
b		160	160	160
c		198	198	198
d		240	240	240
e		140	140	140
f		8,1	8,1	8,1
g		8	8	8
h		303	303	303
M		40	40	40
M*		2 x 40	2 x 40	2 x 40
Øy [max]		27	27	27
Borna para cond. Sección		6	6	6
Transvers. (mm²) min.-max.		-25	-25	-25