

**Panel mounted inlet**

N.º ref. 75326



- 15° inclination
- seawater resistant design are available on request

**Especificaciones técnicas**

Amperios	250 A
Polos	5 p
Voltios	400 V
Sentido horario	6 h
Hertzios	50-60 Hz
Técnica de conexión	bornas de tornillo
Contactos	estándar
Grado de protección	IP 67
Peso	8500 g

**Planos y dimensiones**

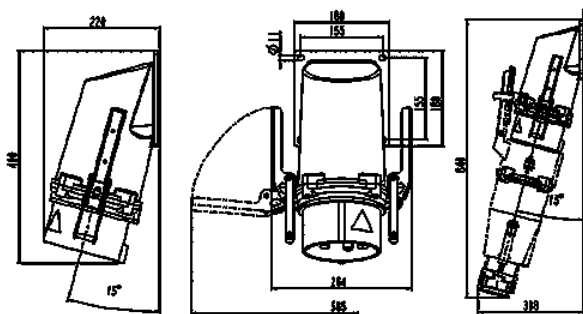

**Plano  
2 MB 248**

**Dim. en mm**