

Base semiempotrable

N.º ref. 809A



- Contacto roscado recta

Especificaciones técnicas

Amperios	32 A
Polos	4 p
Voltios	Transformador de aislamiento
Sentido horario	12 h
Técnica de conexión	bornas de tornillo
Contactos	estándar
Grado de protección	IP 67
Junta de goma	85x75 mm
Agujero de fijación	60x60 mm
Peso	282 g
Marca de verificación	EAC, CQC

Planos y dimensiones

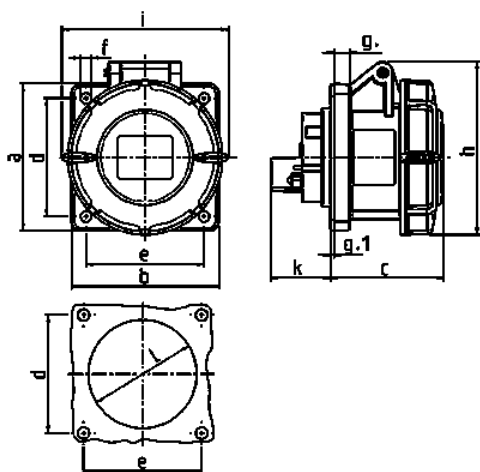

Plano 1 MB 141 Dim. en mm	Amp. Polos	16			32		
		3	4	5	3	4	5
a		75	75	75	85	85	85
b		75	75	75	75	75	75
c		60	61	61	70	70	72
d		60	60	60	60	60	60
e		60	60	60	60	60	60
f		5,5	5,5	5,5	5,5	5,5	5,5
g		8	8	8	8	8	8
g.1		2	2	2	2	2	2
h		83	88	95	99	99	105
i		78	85	96	103	103	110
k		31	32	32	39	39	39
l		43	52	54	58	58	65
Borna para cond. Sección Transvers. (mm ²) min.-max.		1,5 -4	1,5 -4	1,5 -4	2,5 -10	2,5 -10	2,5 -10