

## Clavija mural

N.º ref. 364



- Contacto roscado

## Especificaciones técnicas

Amperios	125 A
Polos	4 p
Voltios	400 V
Sentido horario	6 h
Hertzios	50-60 Hz
Técnica de conexión	bornas de tornillo
Contactos	estándar
Grado de protección	IP67
Peso	2061 g
Marca de verificación	EAC, CQC

## Planos y dimensiones

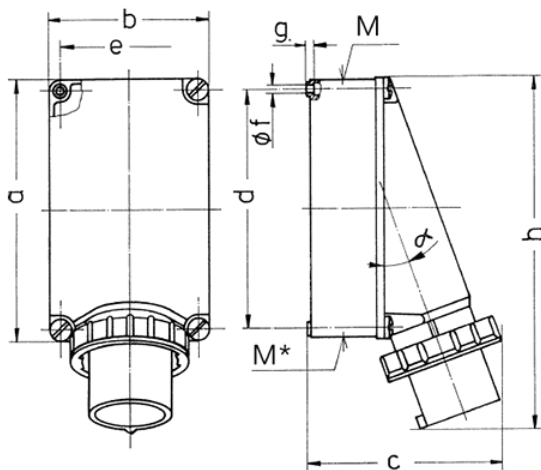

Plano	Amp.	63			125	
		3	4	5	4	5
<b>2 MB 36</b>	<b>Polos</b>					
<b>Dim. en mm</b>	<b>a</b>	170	170	170	264	264
	<b>b</b>	118	118	118	163	163
	<b>c</b>	171	171	171	205	205
	<b>d</b>	134.5	134.5	134.5	240	240
	<b>e</b>	103	103	103	140	140
	<b>f</b>	6,1	6,1	6,1	8,1	8,1
	<b>g</b>	6	6	6	8	8
	<b>h</b>	250	250	250	355	355
	<b>M</b>	40	40	40	50	50
	<b>M*</b>	2x40	2x40	2x40	50	50
	<b>α</b>	25°	25°	25°	20°	20°
	<b>Ø y [max]</b>	27	27	27	38	38
	<b>Borna para cond. Sección</b>	6	6	6	16	16
	<b>Transvers. (mm²) min.-max.</b>	-16	-16	-16	-35	-35