

Base mural
N.º ref. 5641A



- Contacto roscado
- X-CONTACT®
- Desconectable
- Bloqueo mecánico DUO
- Carril DIN
- Se cierra con candado

Especificaciones técnicas

Amperios	63 A
Polos	4 p
Voltios	500 V
Sentido horario	7 h
Hertzios	50-60 Hz
Técnica de conexión	bornas de tornillo
Contactos	X-CONTACT®
Grado de protección	IP 67
Material	plástico
Peso	3950 g

Planos y dimensiones

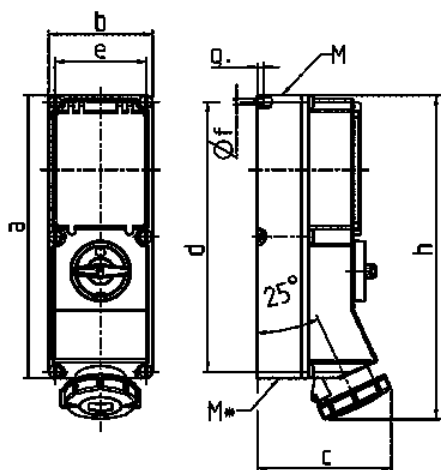

Plano	Amp.	16			32		63	
		1 MB 181/620		Polos	3	4	5	4
Dim. en mm	a	364	364	364	364	364	460	460
	b	134	134	134	134	134	180	180
	c	160	162	163	168	168	202	202
	d	347	347	347	347	347	440	440
	e	117	117	117	117	117	160	160
	f	6,3	6,3	6,3	6,3	6,3	8,1	8,1
	g	8	8	8	8	8	8	8
	h	391	395	398	408	411	505	505
	M	32/40	32/40	32/40	32/40	32/40	40	40
	M*	2x32	2x32	2x32	2x32	2x32	2x40	2x40
	Ø y [max]	27	27	27	27	27	27	27
	Borna para cond. Sección	1,5	1,5	1,5	2,5	2,5	6	6
	Transvers. (mm²) min.-max.	-4	-4	-4	-10	-10	-25	-25